

ALUMINIUM DOORS

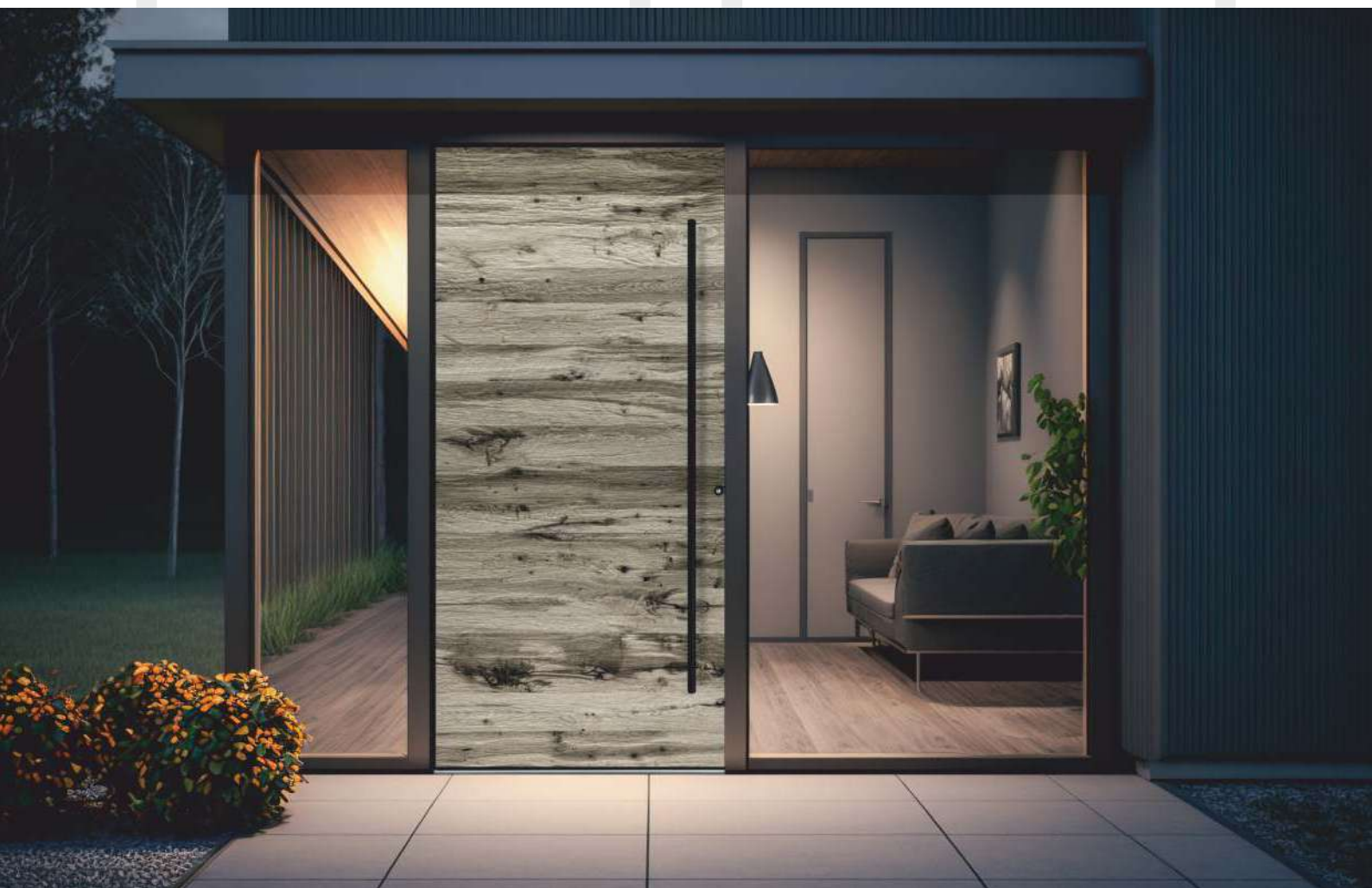

CLASSIC



These models are equipped with externally mounted glass frames and closed versions featuring decorative frames also mounted on the outside. This front door series is available in the systems ADS 95.SI, ADS 95AK.SI, ADS 75.SI, and ADS 75B.SI. In addition, you can choose between single-sided or double-sided leaf-overlapping designs. Applications and ornamental frames can also be installed on the outside or on both sides.



AC 203A

Color: HD Eiche 2
 Glass: Ornament Glass
 Handle: 316 866
 schräge Befestigung

Ud (Wm ² /K)	
EFS	1,3 (Ug 0,7) BFS
	0,94 (Ug 0,5)



AC 207

Color: Granit Nature Fs Metallic
 Glass: Ornament Glass
 Handle: TG 80 schräge Befestigung

Ud (Wm ² /K)	
EFS	1,2 (Ug 0,7) BFS
	0,94 (Ug 0,5)



AC 182A

Color Ral 7016 Fs
 Glass Ornament Glass
 Handle 316 866 oblique attachment

Ud (Wm²/K)
 EFS | 1,2 (Ug 0,7) | BFS | **0,92** (Ug 0,5)



AC 195A

Color Ral 9016 Fs
 Glass Ornament Glass
 Handle 316 866 oblique attachment

Ud (Wm²/K)
 EFS | 1,2 (Ug 0,7) | BFS | **0,91** (Ug 0,5)



AC 183

Color Ral 9016 Fs
 Glass Ornament Glass
 Handle TG 50 oblique attachment

Ud (Wm²/K)
 EFS | 1,3 (Ug 0,7) | BFS | 1,0 (Ug 0,5)



AC 183

Color Ral 6005 Fs, Ral 9016 Fs
 Glass Ornament Glass
 Handle 316 866 oblique attachment

Ud (Wm²/K)
 EFS | 1,3 (Ug 0,7) | BFS | 1,0 (Ug 0,5)



AC 185/AST 185

Color Original Platinum matte metallic
 Glass Ornament Glass
 Handle 316 866 oblique attachment

Ud (Wm²/K)
 EFS | 1,4 (Ug 0,7) | BFS | 0,95 (Ug 0,5)



AC 191/AST 191

Color Verdigris Fs Metallic
 Glass Ornament Glass
 Handle 316 866 oblique attachment

AC 194A

Color Precious Sand Fs Metallic
 Glass Ornament Glass
 Handle TG 60 oblique attachment

Ud (Wm²/K)

EFS | 1,3 (Ug 0,7) | BFS | 1,1 (Ug 0,5)

Ud (Wm²/K)

EFS | 1,3 (Ug 0,7) | BFS | 0,97 (Ug 0,5)



AC 209A

Color Ral 5014 Fs
 Glass Ornament Glass
 Handle 3 16 866 oblique attachment

Ud (Wm²/K)
 EFS | 1,2 (Ug 0,7) | BFS | 0,92 (Ug 0,5)



AC 209

Color Ral 9016 Fs
 Handle TG 50 oblique attachment

Ud (Wm²/K)
 EFS | 1,2* (Ug 0,7) | BFS | 0,84* (Ug 0,5)



AC 190A/AST 190

Color Precious Sand Fs Metallic
 Glass Ornament Glass
 Handle 3 16 866 oblique attachment

Ud (Wm²/K)
 EFS | 1,3 (Ug 0,7) | BFS | 1,0 (Ug 0,5)

SYSTEM ADS.SI

- ☐ Frame profile is made from 75 or 95 mm thick aluminium and has straight or curved lines.
- ☐ Casement profile is made from 85 and 75 mm thick aluminium.
- ☐ Frame and casement profiles include a core thermal insulation weatherstrip that improves their thermal performance.
- ☐ Hard PUR foam core is clad in aluminium and features superior thermal insulation performance.
- ☐ In variants where the casements are covered on both sides and have no glazing, the thermal transmittance of the doors is $U_d = 0.84 \text{ W/m}^2\text{K}$, while in aluminium entrance doors with cladding on one side the U_d value is $1.2 \text{ W/m}^2\text{K}$.



HARDWARE

- ☐ Quality three-dimensional adjustable hinges.
- ☐ 3 or 5-point locking of the leaf.
- ☐ Various options for opening: outside opening, a fingerprint system, electrical opening etc.

GLAZING

- ☐ You can choose from a variety of thermal and acoustic insulation and safety glass.
- ☐ A wide selection of ornaments and vitrages according to your wishes.
- ☐ Finishing the glass with various foils, glass accessories, sandblasting etc.



SURFACE TREATMENT

- ☐ Quality and environmentally friendly powder coating surfaces.
- ☐ You can choose from a wide range of standard colours, metallic colours, imitation wood dekors and colours from RAL colour chart.

OPENING

inward-opening doors, exterior view



DIN left



DIN right

TYPE OVERVIEW view from inside

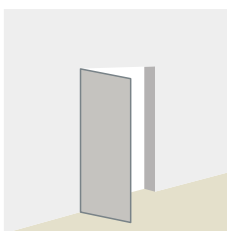

Type 01

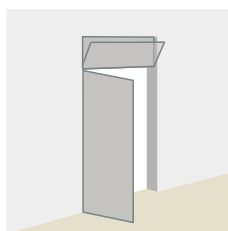

Type 02/03

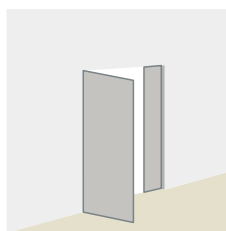

Type 04

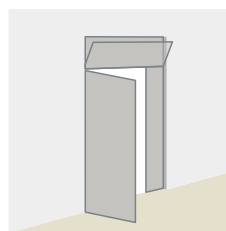

Type 05/06

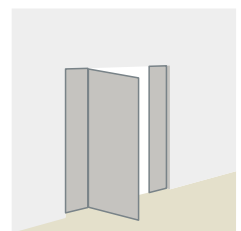

Type 07

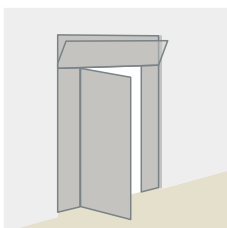

Type 08/09

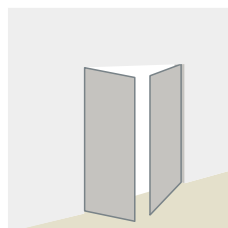

Type 21

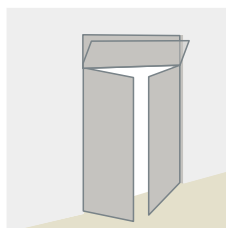

Type 22/23

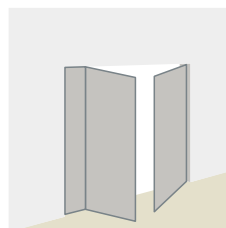

Type 24

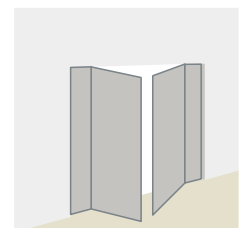

Type 25

Aluminum entrance door **outside**

Model AT 100, system ADS 75B.SI

flush outside

Color: wing Dekor Altholz (Stadelholz- IN), cross-veneered
frame: Cast Iron Fs Metallic



Wood/Alu window **outside**

INO-HA80-MM **flush**

INO-HA80-F **flush**

Color Alu: Cast Iron Fs Metallic

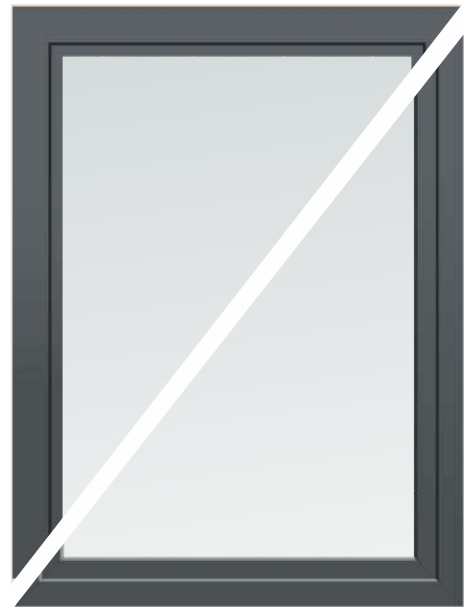

Vinyl/ aluminium window **outside**

Living Top Alu (non-flush)

Color Alu: Cast Iron Fs Metallic

EASY TO USE



Opening with fingerprint
DLine



Opening with fingerprint
Idencom



Handle with integrated
fingerprint dLine



Smart unlock
Multifunktions-Keypad

Aluminum entrance door **inside**

Model AT 100, System ADS 75B.SI

flush inside

Color: Cast Iron Fs Metallic

Wood/Alu window **inside**

INO-HA80-MM **flush**

INO-HA80-F - standard

Color: DB 703



Vinyl/ aluminium window **inside**

Living Top Alu (non-flush)

Color PVC: Cast Iron Fs Metallic



LED LIGHTING



Handle with LED lighting,
with scratch protection
and stainless steel application



Led-Diodes

DIGITAL DOOR VIEWER



with LCD screen



ADS 95AK.SI
square frame

Coating of aluminum on both sides

Ud = 0,81 W/m²K

(Ud value calculated for a door size of 1230 × 2180 mm, without glass cut-out)

Ud = 0,84 W/m²K

(Ud value calculated for a door size of 1100 × 2100 mm, without glass cut-out)



ADS 95.SI
round frame

triple glazing

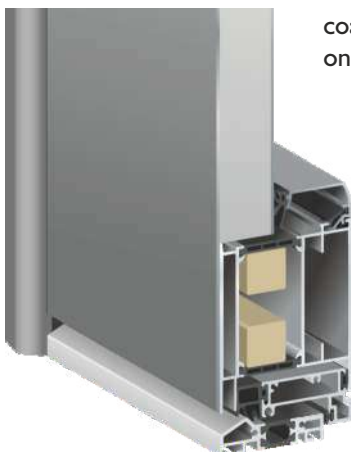

coating of aluminum
on outer side

Ud = 1,2 W/m²K
(ohne Glassausschnitt)



visible door frame
- inside and outside

In these models the wings are visible both inside and outside. They are available in all types of doors except for the Deluxe series.



ADS 75B.SI

Flush on the inside and outside.

Ud = 0,83 W/m²K

(Ud value calculated for a door size of 1230 × 2180 mm, without glass cut-out)

Ud = 0,87 W/m²K

(Ud value calculated for a door size of 1100 × 2100 mm, without glass cut-out)

Coating of aluminum on both sides

Ud = 0,81 W/m²K

(Ud value calculated for a door size of 1230 × 2180 mm, without glass cut-out)

Ud = 0,84 W/m²K

(Ud value calculated for a door size of 1100 × 2100 mm, without glass cut-out)



ADS 75.SI

Flush on the outside

GLAZING SYSTEMS

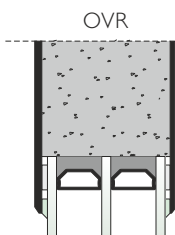

Series **TREND**

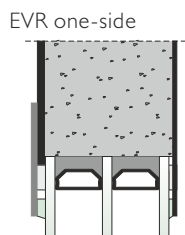

Series **DELUXE**
(standard)

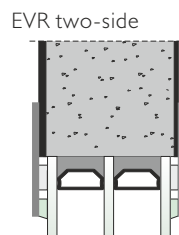

Series **DELUXE**

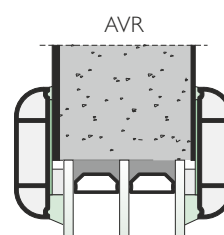

Series **MODERN, CLASSIC**

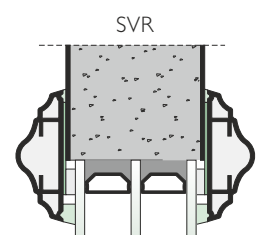

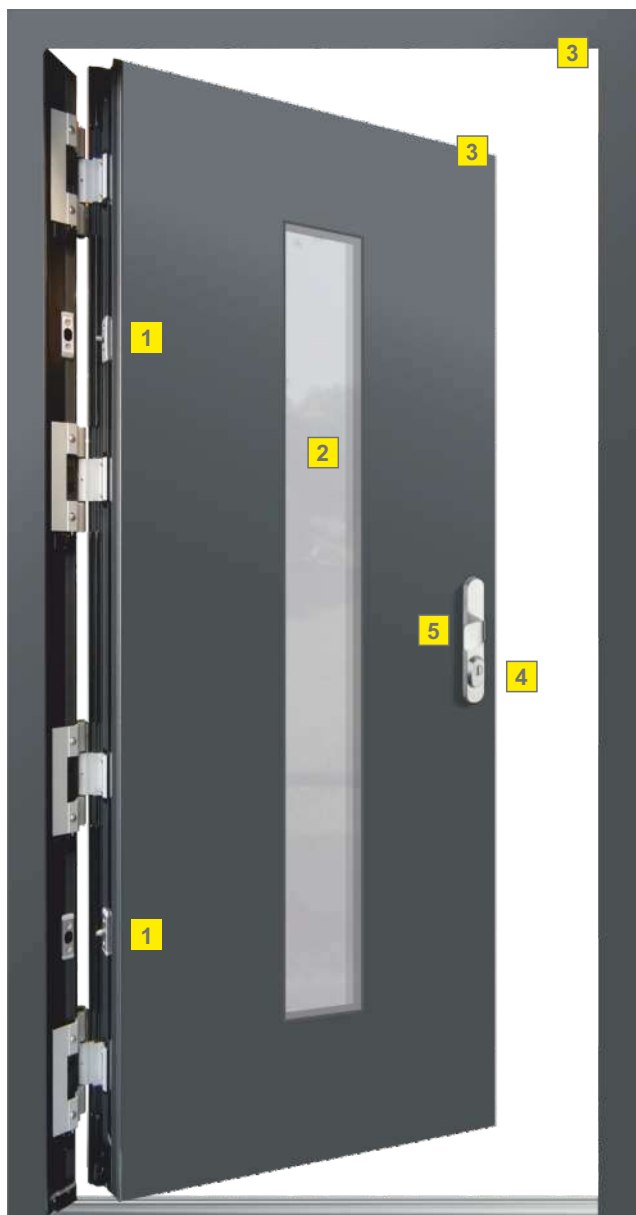

RC2 – we are happy to provide you with detailed advice on this.

In addition to the high quality standard of aluminium front door, these are equipped with a 5-point lock as standard locking.

You can safety upgrade the door with certified RC1 safety levels and RC2 and equip them for a simpler and more practical use.



RC2 VERSION

1 SAFETY BOLT



2 SAFETY GLASS P4A



3 WING LIFT LIMITER



4 SECURITY PROFILE CYLINDER WITH ANTI-DRILL PROTECTION

5 SAFETY KNOB



3 THREE-DIMENSIONAL
ADJUSTABLE HINGES



Up to a door height of 2150 mm
- 3 hinges are installed, over dim. 2151 mm
- 4 hinges are installed (standard)

4 THRESHOLD

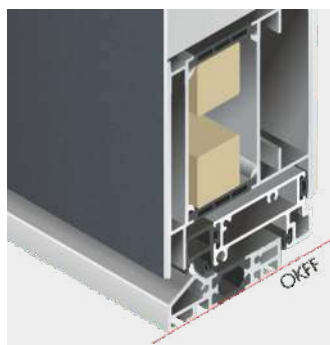

FP1 (standard)

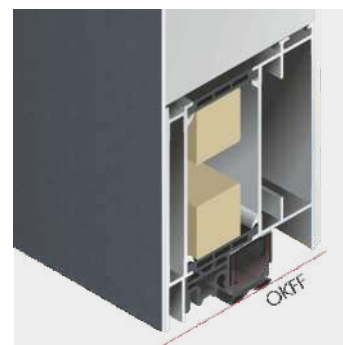

FP5

SECURITY DOOR LOCKS



ATVE 5
5-point lock
 - stainless steel
 with bolts and
 swing hooks

**basic security
 serial**

*mechanical multipoint
 locking system*

*5-point security
 through one main
 latch, 2 bolts, and
 2 swing hooks*



ATVK 5
**5-point lock with
 comfort function**
 - stainless steel
 with bolts and
 swing hooks

- Mechanical opening of the door via handle always possible (convenience opening)
- A free-wheeling cylinder or a thumb turn cylinder is required
- Only possible in combination, except pull handle – inside handle (outside handle not possible)

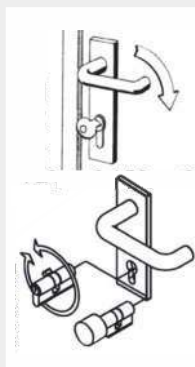

Comfort function
 = quick opening from
 the inside via the handle

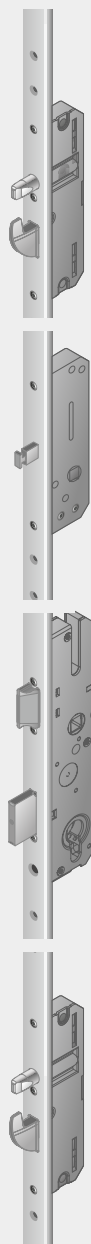

ATVS 5
5-point security lock
 - stainless steel
 with bolts, swing hooks
 and door gap restrictor

The spring-loaded security latch ensures that the door only opens a crack, preventing any unwanted guest from squeezing between the door and frame.

From the inside, the security latch lock can be easily operated via a thumb turn; from the outside, it is operated with a key via the main lock.



ELECTRIC OPENER



CONCEALED DOOR HINGES



Opening inwards
 - 100° opening angle



Opening outwards
 system ADS 75B.SI
 - 100° opening angle

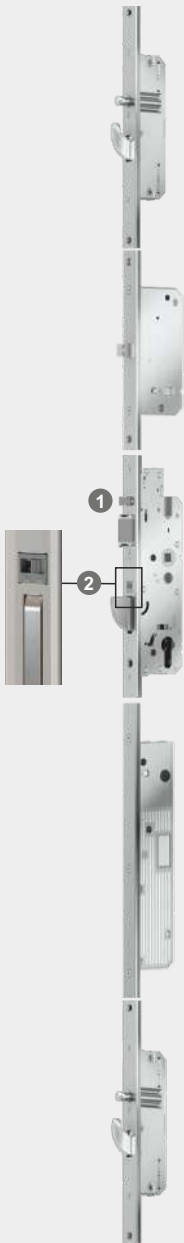

ATVE A
5-point security lock
AVTOMATIC,
MECHANICAL

Automatic multipoint locking system with integrated self-adjustment

- 1 Always reliably secure. To ensure the door is reliably locked at all times, the automatic release latch is integrated.
- 2 Day release: Leave the house without a key. Practical for everyday situations in which you want to leave the building briefly without a key: simply deactivate the automatic function using the day-release slider and release the main lock latch on the frame part.

ATVE A-M
5-point security lock
AVTOMATIC,
MECHANICAL
with motorized function,
including power supply unit

- Locking elements can be mechanically locked
- Unlocking via intercom system, biometrics, etc. (the main lock bolt must not be double-locked)



ATVS 5EA
5-point lock Genius

Stainless steel, including power supply unit, with electromechanical drive, free-wheeling profile cylinder with anti-drill protection and emergency function, including 6 keys.

Attention: Only cylinders marked FZG may be used!

As soon as the door is closed, automatic locking is activated in night mode by the motor (approx. 3 seconds). All available locking elements are extended.

The door can be unlocked manually using the cylinder key or automatically via an external access control system.

When the door is fully locked, it is also possible to retract all locking elements from the inside via the handle and open the door quickly in this way.

PROFILE CYLINDER



Profile cylinder with emergency and danger function and 6 keys (standard)



Profile cylinder with anti-drill protection and 6 keys



Free-wheeling profile cylinder with anti-drill protection and emergency function, including 6 keys

Access control system (ATVE A-M, ATVS 5EA GENIUS)



dLine



dLine black



Smart unilock

The Smart Unilock is an innovative keypad that combines opening via mobile app, fingerprint, code, or RFID in one product.



Idencom

Aluminum entrance door **outside**

Model AT 894, System ADS 95AK.SI

Color: Cast Iron Fs Metallic, HD Walnuss dunkel

house number- stainless steel

HOUSE NUMBER
AS MOTIF ON GLASS



VIEWER



Brass polished / satin chrome

ROSE



Stainless steel
(standard) black

Weatherboard



Different systems
mailboxes



WSE 03, Stainless steel Application



WSE 01, Stainless steel



WSE 02, Stainless steel

Aluminum entrance door **inside**

Model AT 894, System ADS 95AK.SI

Color: Ral 9016 FS

Door closer TS 5000



Interior handles, interior rose

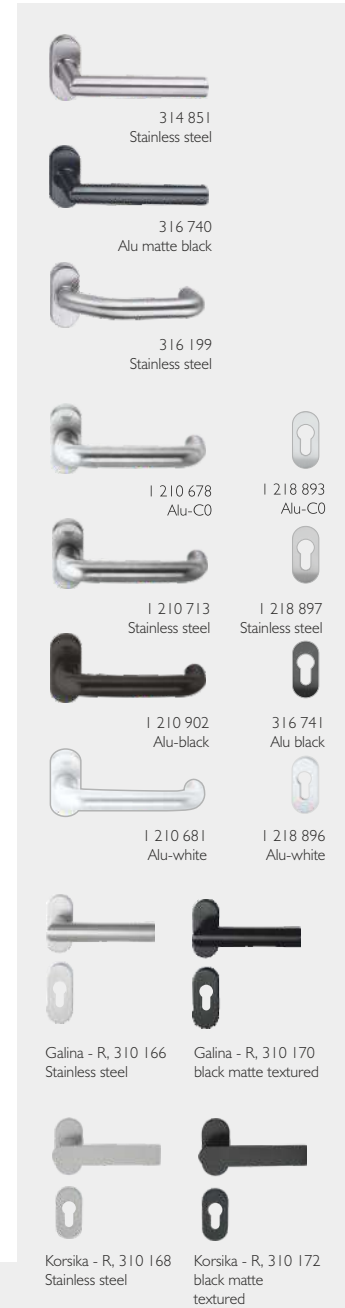

Three-part roller door hinges

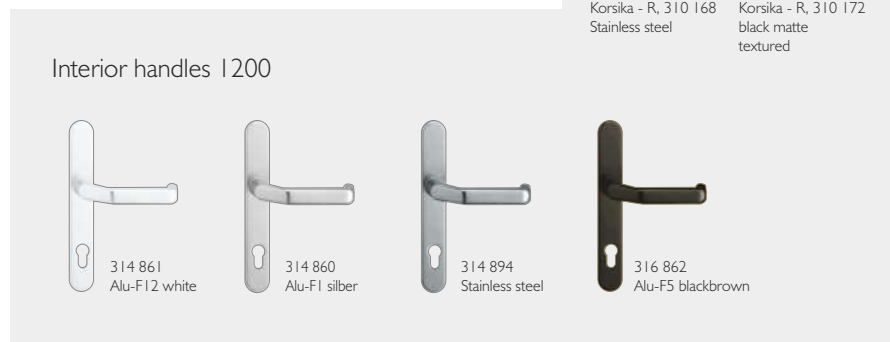

ACCESSORIES

HANDLE SHELLS



EXTERIOR HANDLES



LED diodes, light color white,
LED diode lamp, stainless steel

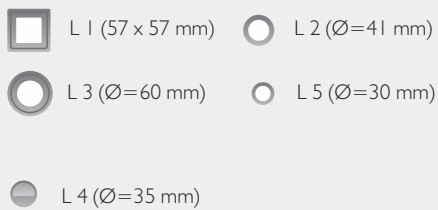

OUTSIDE ROSETTES



Stainless steel matte
ZAE 66R
L=X mm



Stainless steel matte
310 048
L=382 mm



Stainless steel matte
310 047
L=382 mm

DOOR HANDLE SET



Alu - FI silber
314 866



Alu - FI silber
314 863

<p>Stainless steel matte</p> <p>310 036 L=1000 mm</p> <p>310 037 L=1200 mm</p> <p>310 038 L=1400 mm</p> <p>310 039 L=1500 mm</p> <p>310 040 L=1600 mm</p>	<p>Stainless steel matte</p> <p>ZAE 66 L = x</p>	<p>Stainless steel matte</p> <p>314 585 L=400 mm</p> <p>314 586 L=800 mm</p> <p>314 597 L=1200 mm</p> <p>314 598 L=1600 mm</p> <p>316 847 L=1800 mm</p> <p>314 599 L=2000 mm</p>	<p>Stainless steel matte</p> <p>310 017 L=400 mm</p> <p>310 019 L=800 mm</p> <p>310 021 L=1200 mm</p> <p>310 024 L=1500 mm</p> <p>310 025 L=1600 mm</p> <p>310 026 L=1800 mm</p> <p>310 027 L=2000 mm</p>	<p>Stainless steel matte</p> <p>P 3217 L = x</p> <p>P 3202 L=350 mm</p> <p>P 3204 L=550 mm</p> <p>P 3206 L=750 mm</p> <p>P 3208 L=950 mm</p> <p>P 3210 L=1150 mm</p> <p>P 3212 L=1350 mm</p>	<p>Stainless steel matte with cut-out for Idecom fingerprint scanner</p> <p>310 049 L=1000 mm</p> <p>310 050 L=1300 mm</p> <p>310 051 L=1500 mm</p> <p>310 052 L=1600 mm</p>	<p>Stainless steel matte with Led</p> <p>310 058 L=1000 mm</p> <p>310 059 L=1400 mm</p>
---	--	--	---	--	--	---

<p>black matte textured</p> <p>310 041 L=1000 mm</p> <p>310 042 L=1200 mm</p> <p>310 043 L=1300 mm</p> <p>310 044 L=1400 mm</p> <p>310 045 L=1500 mm</p> <p>310 046 L=1600 mm</p>	<p>black</p> <p>ZAE 66-S L = x</p>	<p>black matte textured</p> <p>316 834 L=1000 mm</p> <p>316 835 L=1200 mm</p> <p>316 837 L=1400 mm</p> <p>316 838 L=1500 mm</p> <p>316 839 L=1600 mm</p>	<p>black matte textured</p> <p>310 029 L=1000 mm</p> <p>310 030 L=1200 mm</p> <p>310 032 L=1400 mm</p> <p>310 033 L=1500 mm</p> <p>310 034 L=1600 mm</p> <p>310 035 L=1800 mm</p>	<p>black</p> <p>P 3217-S L = x</p>	<p>Stainless steel matte with cut-out for dLine fingerprint scanner</p> <p>310 053 L=1000 mm</p> <p>310 054 L=1300 mm</p> <p>310 055 L=1400 mm</p> <p>310 056 L=1500 mm</p> <p>310 057 L=1600 mm</p>	<p>Stainless steel matte with LED and cut-out for dLine fingerprint scanner</p> <p>310 060 L=1000 mm</p>
---	--	--	---	--	--	--

<p>Stainless steel matte</p> <p>With angled or straight fastening</p> <p>TG 50 L=500 mm</p> <p>TG 60 L=600 mm</p> <p>TG 80 L=800 mm</p> <p>TG 100 L=1000 mm</p> <p>TG 120 L=1200 mm</p>	<p>Stainless steel matte</p> <p>With angled fastening</p> <p>316 865 L=400 mm</p> <p>316 866 L=600 mm</p> <p>316 867 L=800 mm</p> <p>316 868 L=1000 mm</p> <p>316 869 L=1200 mm</p>	<p>Stainless steel matte</p> <p>With straight fastening</p> <p>316 860 L=400 mm</p> <p>316 861 L=600 mm</p> <p>316 862 L=800 mm</p> <p>316 863 L=1000 mm</p> <p>316 864 L=1200 mm</p>
---	---	---

SCRATCH PROTECTION

<p>Stainless steel</p> <p>381 112 60 X 75 mm</p>	<p>Stainless steel</p> <p>381 114 55 X 75 mm</p>
--	--



Stainless steel 310 174	Stainless steel 310 179	Stainless steel 310 184	Stainless steel matte 316 668	Stainless steel matte 316 671	Stainless steel matte 316 662	Stainless steel matte 316 665
----------------------------	----------------------------	----------------------------	----------------------------------	----------------------------------	----------------------------------	----------------------------------

COLORS

Varied color designs for aluminium surfaces

MASTER COLLECTION textured, metallic



Iceberg Blue
Feinstruktur Metallic



Rumbling Sky
Feinstruktur Metallic



Night Grey
Feinstruktur Metallic



Cast Iron
Feinstruktur Metallic



Russet Copper
Feinstruktur Metallic



Brown
Feinstruktur Metallic

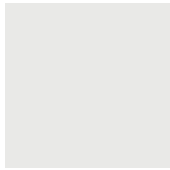

Arctic Ice
Feinstruktur Metallic



Precious Sand
Feinstruktur Metallic



Verdigris
Feinstruktur Metallic



Granit Nature
Feinstruktur Metallic



Volcanic Ash
Feinstruktur Metallic



Elves Bench
Feinstruktur Metallic

ANODIZING COLLECTION matte, metallic

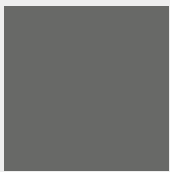

ORIGINAL PLATINIUM
matte Metallic



SILVER DREAM
matte Metallic

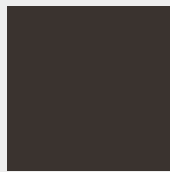

CARBON NIGHT
matte Metallic



DARK COPPER
matte Metallic

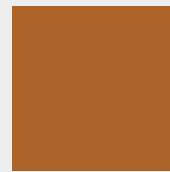

SIMPLY COPPER
matte Metallic

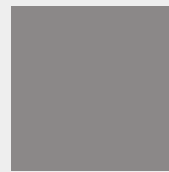

GREY BD
matte Metallic

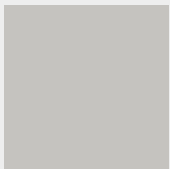

GSPED 0
matte



GSPED 1
matte

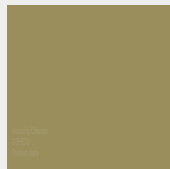

GSPED 2
matte



GSPED 3
matte

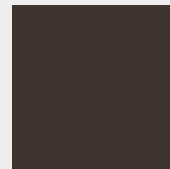

GSPED 4
matte



NOBLE BRONZE
matte Metallic

RAL Colors, matte, textured, smooth, metallic

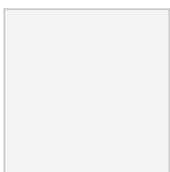

RAL 9016
Feinstruktur



RAL 7040
Feinstruktur

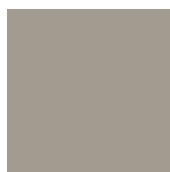

RAL 7039
Feinstruktur



RAL 7012
Feinstruktur



RAL 7015
Feinstruktur



RAL 7016
Feinstruktur



RAL 9006
Metallic glatt



RAL 9007
Metallic Feinstruktur



DB 703
Metallic Feinstruktur



RAL 7021
Feinstruktur



RAL 9005
Feinstruktur



RAL 8019
Feinstruktur

DECOR - APPEARANCE OF STONE



Dekor Concrete
Beton optik



Dekor Beton dunkel

WOOD DEKOR



Dekor Altholz
(Stadelholz-1N)

DECOR EMBOSSED OVERLAY - SERIE TREND AT New Forest



Dekor ATTERSEE



Dekor
WOLFGANGSEE



Dekor TRAUNSEE



Dekor MONDSSEE



Dekor ALTAUSSEE

WOOD DEKOR (struktur)

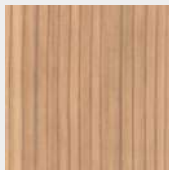

Douglas 6

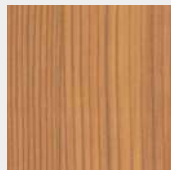

Douglas 7

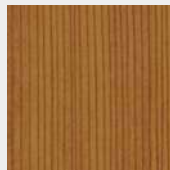

Douglas 2

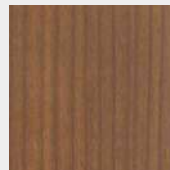

Kirsch 2

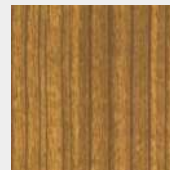

Kirsch 3

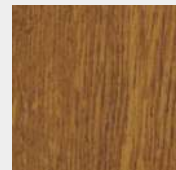

Golden Oak



Eiche 2

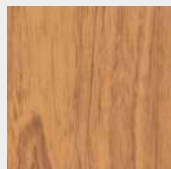

Eiche 4



Eiche dunkel

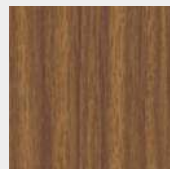

Nuss 1

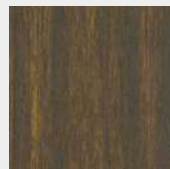

Walnuss dunkel



Wenge

WOOD DEKOR - Series REFINED



Nussbaum FS



Golden Eiche FS



Helle Eiche



Dunkel Eiche

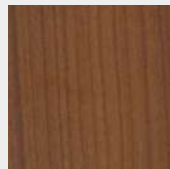

Kirsche

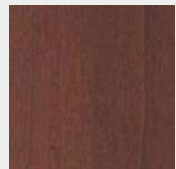

Mahagoni

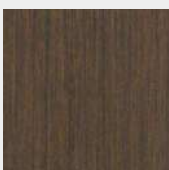

Wenge

ORNAMENTAL GLASS



Kathedral Klein. white



Chinchilla white

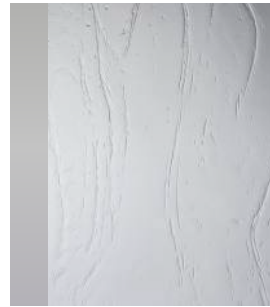

Gothic white

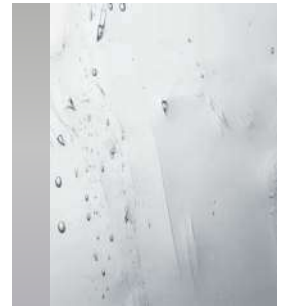

Altdeutsch K white

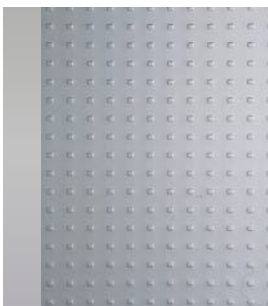

Mastercarre white



Masterligne white

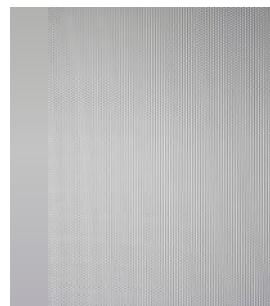

Masterpoint white



Satinato white

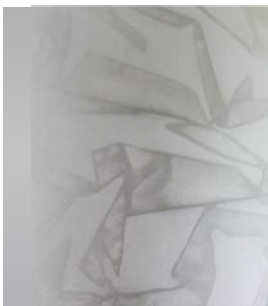

Silk white

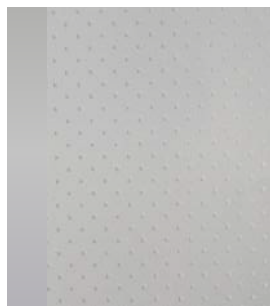

Pave white

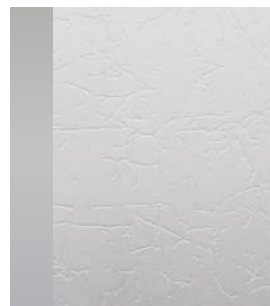

Uadi white

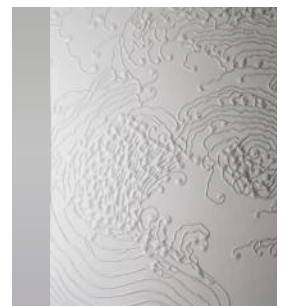

Nebulosa white

Thermal insulating glass

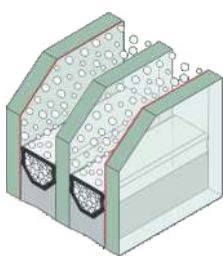

three-layer

Sandblasted glass

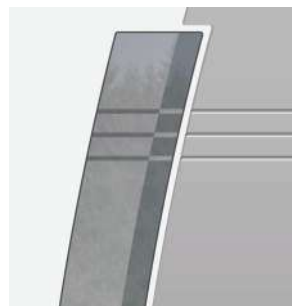

REFINED
AR



Triumph - page 7



Canary/ AST 100A - page 6



Levent - page 7

TREND
New Forest
AT



AT 100 **NF** Attersee



AT 100 **NF** Wolfgangsee
- page 8



AT 100 **NF** Mondsee
- page 9



AT 100 **NF** Traunsee
- page 9



AT 100/ AST 100A **NF** Altausee
- page 9

TREND
AT



AT 100A/ AST 100A - page 21



AT 101 - page 21



AT 102 - page 21



AT 100 - page 11



AT 121 - page 15



AT 131 - page 12



AT 153A - page 31



AT 255 - page 31



AT 264 - page 17

OVERVIEW OF MODELS



AT 264A/AST 100A - page 13



AT 265/AST 100A - page 12



AT 265A - page 17



AT 266 - page 13



AT 266A - page 13



AT 267 - page 29



AT 801B - page 18



AT 810/AST 100A - page 15



AT 843/AST 100A - page 29



AT 862A/AST 100A - page 18



AT 863A/AST 100A - page 26



AT 863B - page 26



AT 863C - page 27



AT 864/AST 100A - page 28



AT 867 - page 20



AT 875A - page 29



AT 883/AST 100A - page 31



AT 887 - page 30



AT 887B - page 30



AT 891A - page 20



AT 894 - page 11



AT 904 - page 28



AT 906 - page 19



AT 906A - page 19



AT 907 - page 15



AT 909/AST 100A - page 14



AT 919 - page 14



AT 924A/AST 100A - page 23



AT 934 - page 25



AT 941A/AST 100A - page 19



AT 943 - page 27



AT 944 - page 22



AT 945A- page 22



AT 946A- page 23



AT 946B - page 23



AT 947/AST 100A - page 27



AT 948/AST 100A- page 25

DELUXE
AD



AD 801A - page 35



AD 801A/AST 100A - page 35



AD 801B - page 33



AD 843A - page 33

OVERVIEW OF MODELS

MODERN AM



AD 863D - page 35



AD 945/ AST 100A - page 34



AD 945 - page 34



AM 132A - page 38



AM 132A - page 38



AM 131 - page 39



AM 134B - page 37



AM 156 - page 37



AM 170 - page 39



AM 170/ AST 100A - page 39

CLASSIC AC



AC 182A - page 42



AC 183 - page 43



AC 183 - page 43



AC 185/ AST 185 - page 43



AC 190A/ AST 190 - page 45



AC 191/ AST 191 - page 44



AC 194A - page 44



AC 195A - page 42



AC 203A - page 41



AC 207- page 41



AC 209A - page 45



AC 209 - page 45

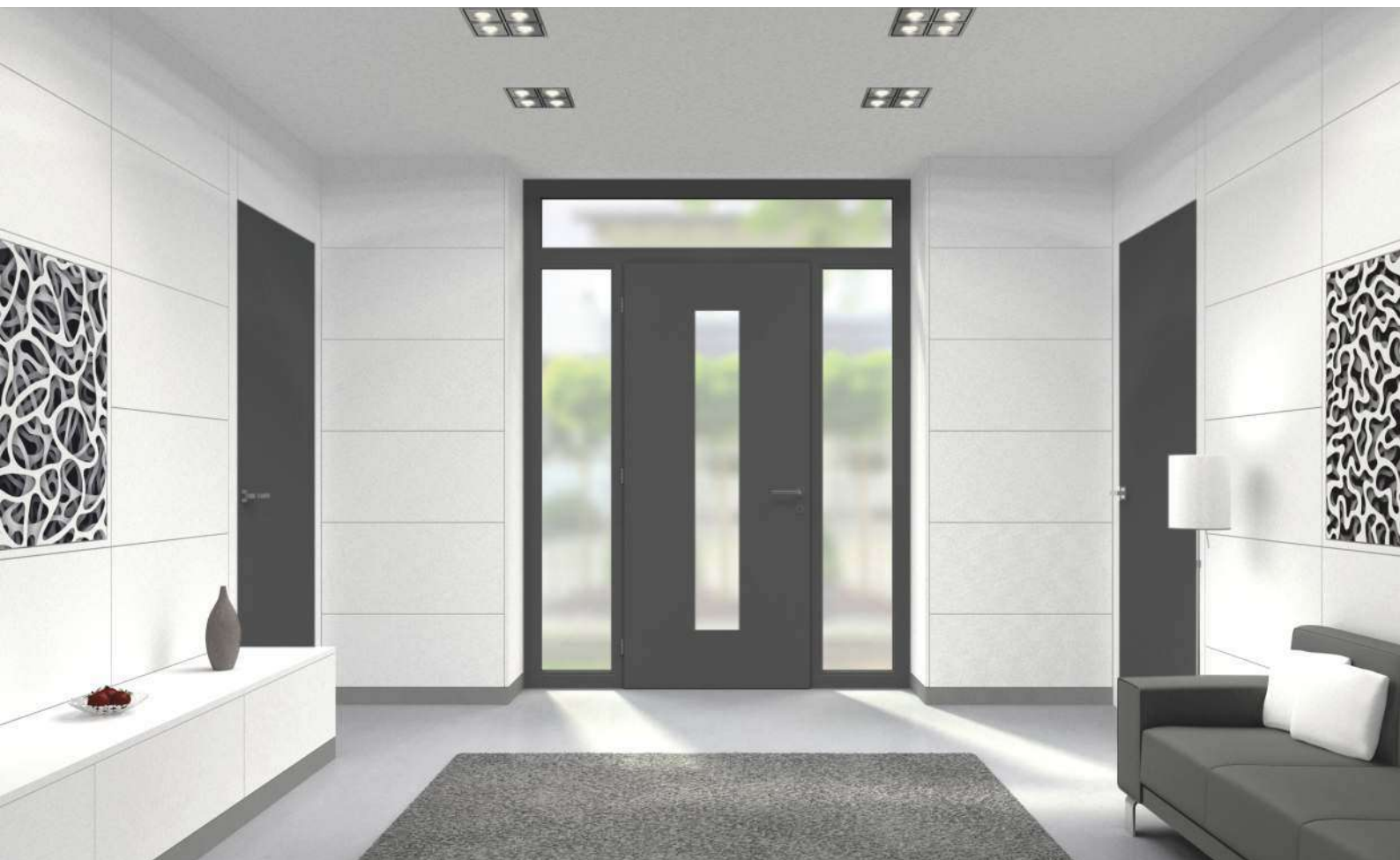

Due to printing-related factors, color deviations may occur between the images shown in this brochure and the original products..

Inles d.d.

SI - 1310 Ribnica, Kolodvorska 22
SLOVENIA

tel.: +386 1 8377 100

e-mail: info@inles.si



www.inles.net